



SYSTRONIK

Messtechnologie

SYSTRONIK
Elektronik u. Systemtechnik GmbH
Gewerbestr. 57
D 88636 Illmensee



Tel.: +49 (0) 7558 / 9206-0
Fax: +49 (0) 7558 / 9206-20

E-Mail: info@systronik.de
Internet: www.systronik.com

Operating Instructions

Flue gas analysis computer Type: MULTILYZER NG

O ₂ , CO _{H2} , differential pressure	Part No.: M041 02 210
O ₂ , CO _{H2} , NO, differential pressure	Part No.: M041 03 210
O ₂ , CO _{H2} , CO _{20.000} , differential pressure	Part No.: M041 12 210
O ₂ , CO _{H2} , CO _{20.000} , NO, differential pressure	Part No.: M041 08 210

-  Read instructions before using device!
-  Observe all safety information!
-  Keep instructions for future use!

Contents

1	About this manual.....	4
1.1	Precautions	4
1.2	Explanation of symbols and typeface	4
2	Safety	5
2.1	Intended use	5
2.2	Predictable incorrect application	5
2.3	Safe handling	5
2.4	Staff qualification	6
2.5	Modifications to the product	6
2.6	Usage of spare parts and accessories.....	6
2.7	Liability information	6
3	Product description.....	6
3.1	Keyboard function	7
3.2	Display.....	7
3.3	Measurement and calculation parameters.....	8
3.4	Measuring procedure	9
4	Specifications	11
4.1	Calculation formulae (extract)	14
4.2	Approvals, tests and conformities	15
5	Transportation and storage	15
6	Commissioning	16
6.1	Connecting scheme	16
7	Start menu	17
8	Menu “Measure”	18
8.1	Programme “Flue gas”	19
8.2	Programme “Temperature”	37
8.3	Programme “Pressure”	38
8.4	Programme “CO(O ₂) Measurement”	39
9	Menu “Macro Start”	40
10	Menu “Time-Date”	41
11	Menu “Configuration”	43
11.1	Change order of measured values on the display	44
11.2	Configure list of fuels.....	46
11.3	Change settings	50
11.4	Set default settings.....	54
12	Menu “Memory”	55

13	Operation.....	56
13.1	Notice concerning measurement of SO ₂ and NO ₂ (option)	56
13.2	Battery/Line Voltage Operation	56
13.3	Charging the batteries.....	57
14	Maintenance	59
15	Troubleshooting.....	59
16	Shutting down and disposal.....	61
17	Spare parts and accessories	61
18	Warranty	62
19	Copyright	62
20	Customer satisfaction	62
21	Addresses.....	62
22	Appendix.....	63
22.1	Declaration of conformity	63

1 About this manual

This instruction manual is part of the product.

- ▶ Read this manual before using the product.
- ▶ Keep this manual during the entire service life of the product and always have it readily available for reference.
- ▶ Always hand this manual over to future owners or users of the product.

1.1 Precautions

WARNING TERMType and source of the danger is shown here.



- ▶ Precautions to take in order to avoid the danger are shown here.

There are three different levels of warnings:

Warning term	Meaning
DANGER	Immediately imminent danger! Failure to observe the information will result in death or serious injuries.
WARNING	Possibly imminent danger! Failure to observe the information may result in death or serious injuries.
CAUTION	Dangerous situation! Failure to observe the information may result in minor or serious injuries as well as damage to property.

1.2 Explanation of symbols and typeface

Symbol	Meaning
☑	Prerequisite for an activity
▶	Activity consisting of a single step
1.	Activity consisting of several steps
↪	Result of an activity
•	Bulleted list
Text	Indication on a display
Highlighting	Highlighting

2 Safety

2.1 Intended use

The MULTILYZER NG flue gas analysis computer is exclusively suitable for the use in the following application areas:

- Professional settings and control-measurements at all small-firings-facilities (low temperature- and burner-value-boilers and -thermal) for gas and oil applicable.
- With a second CO measuring cell (option) you can also use the instrument for facilities for solid fuels as wood, coal etc.
- Measurements at bivalent and power modulatory communal heating stations.

Any use other than the use explicitly permitted in this instruction manual is not permitted.

2.2 Predictable incorrect application

The MULTILYZER NG flue gas analysis computer must never be used in the following cases:

- Hazardous areas (ex)
If the device is operated in hazardous areas, sparks may cause deflagrations, fires or explosions
- **Einsatz als Sicherheits(alarm)-Gerät oder kontinuierliches Messgerät.**

2.3 Safe handling

The MULTILYZER NG flue gas analysis computer represents state-of-the-art technology and is made according to the pertinent safety regulations. Each device is subjected to a function and safety test prior to shipping.

- ▶ Operate the MULTILYZER NG flue gas analysis computer only when it is in perfect condition. Always observe the operating instructions, all pertinent local and national directives and guidelines as well as the applicable safety regulations and directives concerning the prevention of accidents.
- ▶ **Vor jedem Betrieb des MULTILYZER NG eine optische Gesamtüberprüfung des Messgerätes (inklusive des Zubehörs, falls vorhanden) durchführen, um eine fehlerfreie Betriebsweise des Gerätes sicherzustellen.**

WARNING**Danger due to electricity.**

- ▶ Do not touch parts under voltage with the instrument or the sensor.

2.4 Staff qualification

The product may only be mounted, commissioned, operated, maintained, shut down and disposed of by qualified, specially trained staff.

Electrical work may only be performed by trained electricians qualified in accordance with the local and national directives.

2.5 Modifications to the product

Changes or modifications made to the product by unauthorised persons may lead to malfunctions and are prohibited for safety reasons.

2.6 Usage of spare parts and accessories

Usage of unsuitable spare parts and accessories may cause damage to the product.

- ▶ Use only genuine spare parts and accessories of the manufacturer (refer to chapter 17, page 61).

2.7 Liability information

The manufacturer shall not be liable for direct or consequential damage resulting from failure to observe the technical instructions, guidelines and recommendations.

The manufacturer and the sales company shall not be liable for costs or damages incurred by the user or by third parties in the usage or application of this device, in particular in case of improper use of the device, misuse or malfunction of the connection, malfunction of the device or of connected devices. The manufacturer or the sales company shall not be liable for damages resulting from any use other than the use explicitly permitted in this instruction manual.









The manufacturer shall not be liable for misprints.

3 Product description

The MULTILYZER NG flue gas analysis computer is a multiple - function analyser with integrated calculating functions. Measurements are in accordance with the general regulations set forth by the German "BIMSchV" at all kinds of combustion plants within the framework of the monitoring of exhaust systems.

MULTILYZER NG has a USB interface for PC, laptop, notebook, etc. and a wireless infrared printer-interface.

3.1 Keyboard function

Key	Function
	Register/function key.
	Backlight on/off.
	Change register buttons line.
	Switch to another row./Start macro or waste gas measurement.
	Gas pump on/off.
	Close function or programme, cancel procedure.
	Enter.
	Device on/off.

3.2 Display

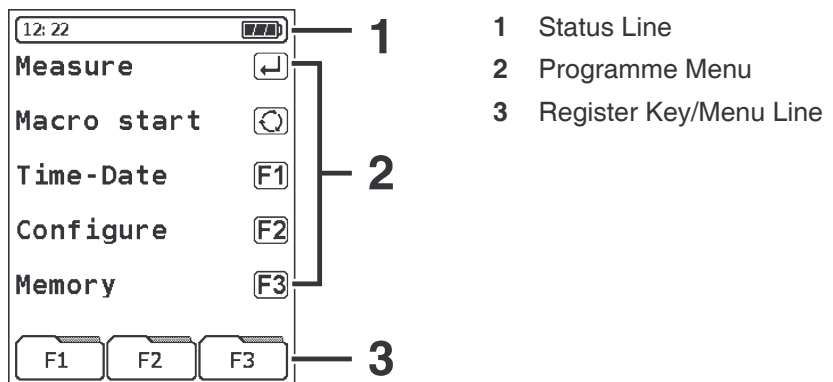

Fig. 1: Display using the example of the start menu

Status Line

This line continuously shows the status of certain information such as remaining battery power, HOLD-function, sensor-alerts, operation of the pump, chosen fuel, time etc. The priority of the information shown thereby depends on the mode and function-specific criteria respectively.

Programme Menu

Out of this menu programmes can be chosen and started. **Zwischenfelder können die selektive Programmauswahl unterstützen.**

Register Key/Menu Line

The functions shown on the display can be selected with the register keys. In some menus the keys F1, F2 and F3 have several functions that can be rotated by pressing the button in the centre of the keypad.

3.3 Measurement and calculation parameters

Table 1: Readings

Display	Measured medium	Unit
T.Gas	Waste or flue gas temperature	°C, °F
T. Room	Air or ambient temperature	°C, °F
O ₂	Oxygen content	% Volume
CO	Carbon monoxide content	ppm, mg/m ³ , mg/kWh, mg/MJ
CO _{max}	Maximum carbon monoxide content	ppm, % Volume
Draft	Draft/Pressure	hPa, mbar, mmWs, mmHg, inWc, inHg, Psi
NO	Nitrogen monoxide content (option)	ppm, mg/m ³ , mg/kWh, mg/MJ
SO ₂	Sulphur dioxide content (option)	ppm, mg/m ³ , mg/kWh, mg/MJ
NO ₂	Nitrogen dioxide content (option)	ppm, mg/m ³ , mg/kWh, mg/MJ
CO+	Carbon monoxide content, grob (option)	% Volume

Table 2: Calculated values

Display	Measured medium	Unit
CO ₂	Carbon dioxide	% Volume
CO _{0%}	Carbon monoxide, undiluted	ppm
Effi.	Combustion efficiency	%
Ex.air	Excess air value	λ
qA	Waste gas losses	%
Dewpnt	Fuel specific dew point	°C, °F
T.Diff	Differential temperature (TG-TA)	°C, °F
NO _x	Nitride oxides (option)	ppm, mg/m ³ , mg/kWh, mg/MJ
NO ref.	Nitrogen monoxide, undiluted (option)	ppm
NO _x ref.	Nitric oxides, undiluted (option)	ppm
SO ₂ ref.	Sulphur dioxide, undiluted (option)	ppm
NO ₂ ref.	Nitrogen dioxide, undiluted (option)	ppm
EB	Emissionen, bezogen auf den Bezugssauerstoffgehalt (Option, nur in Verbindung mit Festbrennstoffen)	ppm

3.4 Measuring procedure

Table 3: Measuring procedure

Function	Explanation
Temperature Measurement	K-type thermocouple NiCr-Ni
O ₂ - Measurement	Electrochemical measuring cell
CO- Measurement	Electrochemical measuring cell
NO- Measurement (Option)	Electrochemical measuring cell
SO ₂ - Measurement (Option)	Electrochemical measuring cell
NO ₂ - Measurement (Option)	Electrochemical measuring cell
Pressure/Draft Measurement	Piezo-resistive sensor with internal temperature compensation

Function	Explanation
Measuring Duration	Short-term memory measurements of max. 60 minutes are possible, followed by a new calibration phase with ambient air.
Waste Gas Measurement	Via an external water separator and filter, the waste gas is fed to the sensors by means of a gas feed pump.
Sensor Calibration	After having switched on the instrument there is a calibration phase that takes 60 seconds after a cold start. For repetition measurements it takes 10 seconds (restart).
CO-Sensor Protection	The standard equipped CO-Sensor with dynamic H ₂ -compensation is protected automatically by means of a separate flushing pump when the upper boundary of the measurement range is reached (> 4.000 ppm). By doing so the sensor is supplied with sufficient fresh air from the environment of the device. The measurement starts again automatically as soon as the value falls below 1.600 ppm. During the active flushing phase the other readings aren't influenced.
Waste Gas Sampling	This is done by means of a suitable probe which enables either a "One-Point-Measurement" (combi probe) or a "Multi-Point-Measurement" (multi-hole probe).

4 Specifications

Table 4: Description of the device

Parameter	Value
General specifications	
Dimensions (W x H x D)	95 x 215 x 45 mm
Weight	Approx. 750 to 900 g (26-35 oz.) (depends on equipment with sensors)
Display	Hi-res LCD-Module that can show graphical items. Either 5 or 10 readings plus menu line can be displayed at a time.
Data communication	USB-interface and wireless infrared printer-interface. Optional: bi-directional IrDA-Interface and radio-interface (upon request)
Printer	external infrared-thermo printer (Euro-Printer or HP84420B)
Memory	Max. 100 memory blocks including dynamic memory management and directory/file structure
Electrical supply	NiMH-battery 6 V/2 Ah, external power adapter and charger
Operating temperature range	
Ambient	+5 °C to +40 °C
Storage	-20 °C to +50 °C

Table 5: Physical specifications

Parameter	Value
Waste or flue gas temperature measurement	
Range	-20 °C to +1000 °C (-4 °F to 1,832 °F)
Accuracy	± 2 °C + 1 digit (-20 °C to 0 °C/-4 °F to 32 °F) ± 1 °C (0 °C to +200 °C/32 °F to 392 °F) ± 0.5 % of reading (above +200 °C/392 °F)
Resolution	1 °C
Sensor	K-Type thermocouple NiCr-Ni

Parameter	Value
Combustion air temperature measurement	
Range	-20 °C to +1000 °C (-4 °F to 1.832 °F)
Accuracy	± 2 °C + 1 digit (-20 °C to 0 °C / -4 °F to 32 °F) ± 0.5 °C + 1 digit (0 °C to +200 °C / 32 °F to 392 °F) ± 0.5 % vom Messwert (ab +200 °C)
Resolution	0.1 °C
Sensor	K-Type thermocouple NiCr-Ni
Pressure measurement	
Range	± 70 hPa (nominal) / ± 130 hPa (maximal)
Accuracy	± 0.02 hPa + 1 digit (0 hPa to ±2.00 hPa)
Resolution	± 1 % of reading (±2.01 hPa to ±70.0 hPa) ± 2 % of reading (±70.1 hPa to ±130.0 hPa) 0.01 hPa (up to 20.99 hPa); 0.1 hPa (above 21.0 hPa)
Sensor	Semiconductor sensor
Oxygen (O₂) measurement	
Range	0-21.0 % Volume
Accuracy	± 0.2 % Volume of reading
Resolution	0.1 % Volume
Sensor	Electro-chemical cell
Response time (T90)	50 seconds
Carbon dioxide (CO₂) calculation	
Range	0 to CO _{2 max} (fuel-specific)
Accuracy	± 0.2 % Volume of reading
Resolution	0.1 % Volume
Sensor	Calculated from O ₂ measurement
Response time (T90)	50 seconds
Carbon monoxide (CO) measurement (with H₂ compensation)	
Range	0-4000 ppm

Parameter	Value
Accuracy	3 ppm (up to 20 ppm) 5 % of reading (above 20 ppm)
Resolution	1 ppm
Sensor	Electro-chemical cell
Response time (T90)	60 seconds

Table 6: Physical specifications – options

Parameter	Value
Nitrogen monoxide (NO) measurement	
Range	0-2000 ppm
Accuracy	5 ppm (up to 50 ppm) 5 % of reading
Resolution	1 ppm
Sensor	Electro-chemical cell
Response time (T90)	60 seconds
COhigh measurement (without H₂ compensation)	
Range	0-2.0 % Volume (20,000 ppm)
Accuracy	5 % of reading (± 1 digit)
Resolution	0.01 % Volume
Sensor	Electro-chemical cell
Response time (T90)	60 seconds
SO₂-measurement	
Range	0-2000 ppm
Accuracy	10 ppm (up to 200 ppm) 5 % of reading (up to 200 ppm)
Resolution	1 ppm
Sensor	Electro-chemical cell
Response time (T90)	150 seconds

Parameter	Value
NO₂-measurement	
Range	0-200 ppm
Accuracy	10 ppm (up to 50 ppm) 10 % of reading (above 50 ppm)
Resolution	1 ppm
Sensor	Electro-chemical cell
Response time (T90)	180 seconds

4.1 Calculation formulae (extract)

Calculation of the CO₂ value

$$\text{CO}_2 = \text{CO}_{2\text{max}} * \left(1 - \frac{\text{O}_2}{21}\right) \text{ in \%}$$

CO _{2max}	Max. CO ₂ value (fuel-specific) in % Volume
O ₂	Measured oxygen content in % Volume
21	Measured oxygen content in % Volume

Calculation of the waste gas loss

$$qA = (\text{T.Gas} - \text{T.Air}) * \left(\frac{A_2}{21 - \text{O}_2} + B\right) \text{ in \%}$$

T.Gas	Waste/flue gas temperature in °F or °C
T.Air	Combustion/ambient temperature in °F or °C
A ₂ , B	Fuel-specific factors

Calculation of the excess air value Lambda

$$\text{Lambda} = \frac{\text{CO}_{2\text{max}}}{\text{CO}_2} = \frac{21}{21 - \text{O}_2}$$

Calculation of the combustion efficiency value (Eta)

$$\text{Eta} = 100 - qA \text{ in \%}$$

Calculation of CO 0% (undiluted)

$$\text{CO}_{\text{und.}} = \text{CO} * \text{Lambda}$$

CO _{und.}	Content of carbon monoxide, undiluted
CO	Reading for CO

4.2 Approvals, tests and conformities

This instrument is for measurement appropriate the German "1. BundesImmissionsSchutzVerordnung" (1. BImSchV) and EN 50379-2 und TÜV-geprüft und erfüllt zugleich die gültigen Richtlinien gemäß 89/336/EWG und KÜO (Kehr- und Überwachungsordnung der Bundesländer)

Das Messgerät ist zur Messung nach der 1. Bundesimmissionsschutzverordnung (1. BImSchV) zugelassen.

5 Transportation and storage

CAUTION Damage to the device due to improper transportation.



- ▶ Do not throw or drop the device.
-

CAUTION Damage to the device due to improper storage.



- ▶ Protect the device against shock when storing it.
 - ▶ Store device in a clean and dry environment.
 - ▶ Store device only within the admissible temperature range.
 - ▶ Store device away from paint, solvent and glue.
-

6 Commissioning

6.1 Connecting scheme

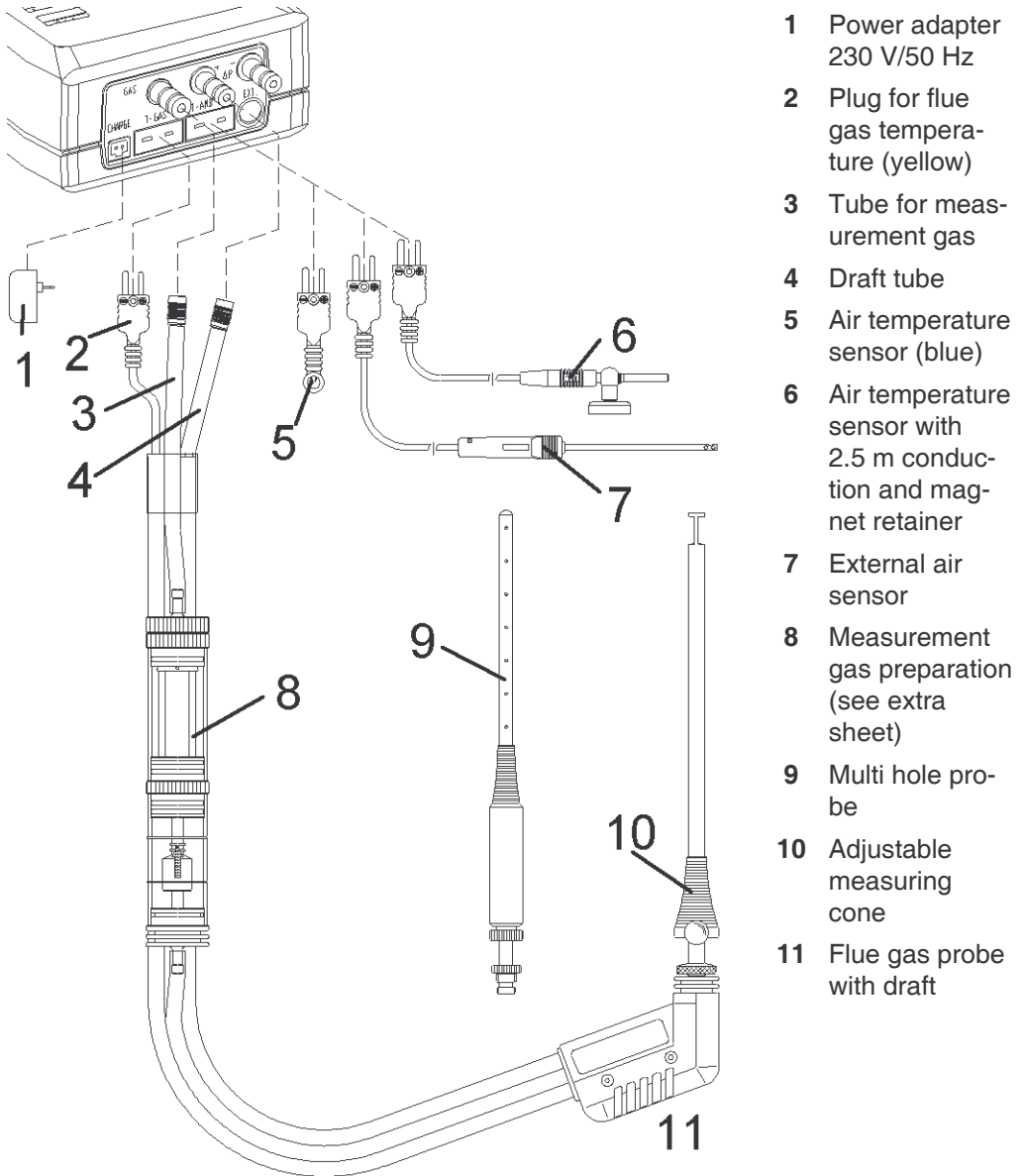

Fig. 2: Connecting scheme

7 Start menu

1. Switch on device:



↳ Initialisation screen is shown:

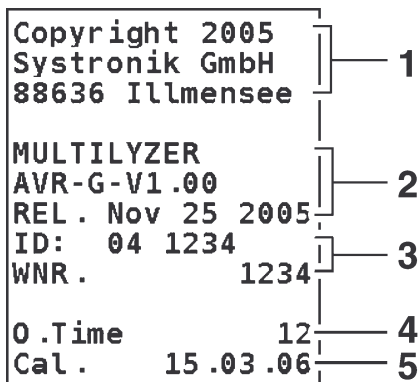

- 1 Producer information
- 2 Version of software
- 3 Part No.
- 4 Hours in use
- 5 Date of next calibration

Fig. 3: Initialisation screen

2. Hold initialisation screen:



3. Switch the backlight on/off:









4. Continue:

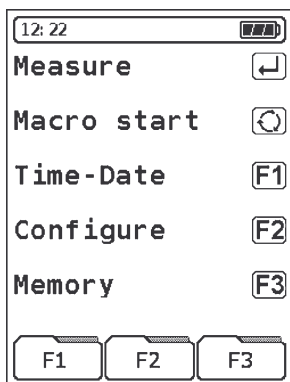

↳ The implemented company symbol appears on the display.

↳ The programme starting screen appears on the display:





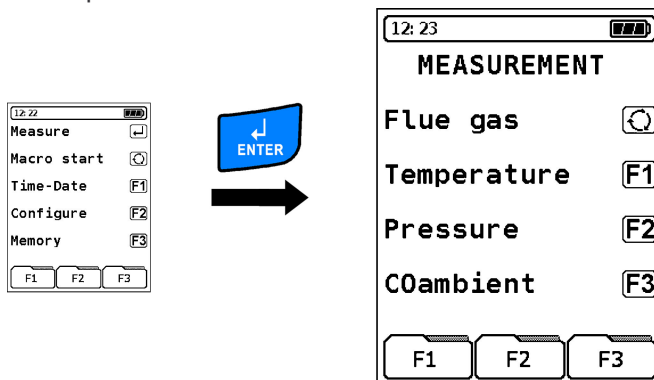

Key	Function
	Start the "Measure" menu, refer to chapter 8, page 18.
	Start the "Macro Start" menu, refer to chapter 9, page 40.
	Start the "Time-Date" menu, refer to chapter 10, page 41.
	Start the "Configure" menu, refer to chapter 11, page 43.
	Start the "Memory" menu, refer to chapter 12, page 55.

8 Menu "Measure"

- Open the "Measure" menu.



Key	Function
	Start the "Flue gas" programme, refer to chapter 8.1, page 19.
	Start the "Temperature" programme, refer to chapter 8.2, page 37.
	Start the "Pressure" programme, refer to chapter 8.3, page 38.

Key	Function
	Start the "CO ambient Measurement" programme, refer to chapter 8.3, page 38.
	Close menu and back to the start menu.

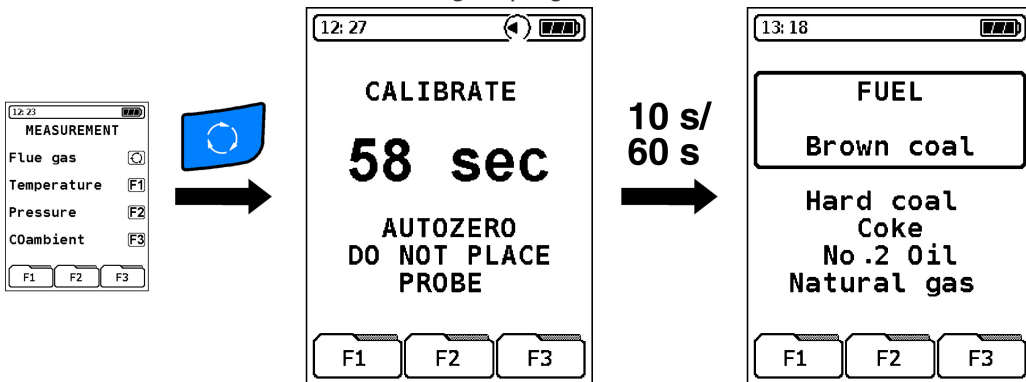

8.1 Programme "Flue gas"

- ▶ Start the "Flue gas" programme.



After a cold start the calibration phase takes 60 seconds. If a restart is done out of the measuring programme the calibration phase takes only 10 seconds.

After the calibration the last used fuel appears on the screen.

Key	Function
	Change fuel.
	Confirm the selected fuel (fuel in the framed box).

- Open the "Flue gas" measuring menu.

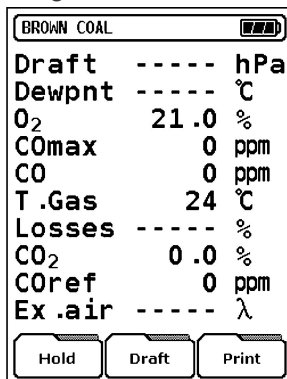
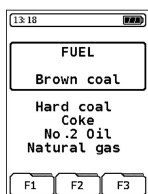





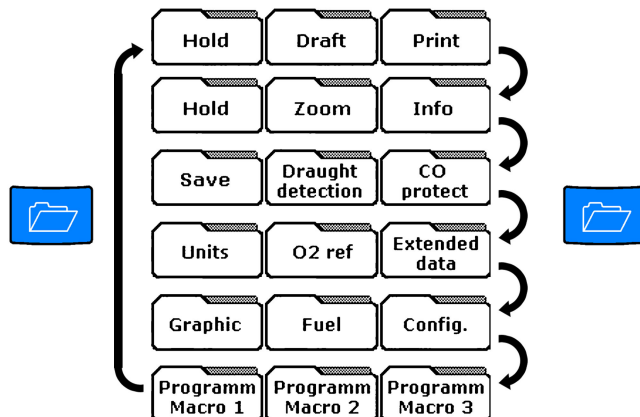

Key	Function
	Backlight on/off.
	Change the register buttons line (new function buttons), see below.
	Change the way in which the readings are shown line by line (uni directional line change).
	Gas pump on/off.
	Reset CO _{max} value.

- Change the register buttons line.





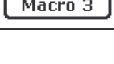

Register	Function
	Function "Hold": Hold readings. Refer to page 35.
	Measuring menu "Draft": Flue-measurement. Refer to page 22.
	Function "Print": Print readings. Refer to page 36.
	Function "Zoom": Change layout of readings (5 or 10 lines). Refer to page 35.
	Extra menu "Info": Start information menu (shows data about fuels and condition of sensors). Refer to page 23.
	Menu "Memory". Refer to chapter 12, page 55.
	Extra menu "Draught detection". Refer to page 25.
	Function "CO protect": Manual CO-Sensor protection). Refer to page 36.
	Extra menu "Units": Change units of readings. Refer to page 26.
	Extra menu "O ₂ -reference". Refer to page 27.

Register	Function
	Extra menu "Enter data": Enter additional data: Enlarge measurement protocol. Refer to page 28.
	Extra menu "Graphic": Start analysis software: Graphic representation of values. Refer to page 32.
	Menu "Fuel". Refer to page 33.
	Menu "Configuration". Refer to chapter 11, page 43.
  	Function "Programme macros": Save measurement combinations as macros. Refer to page 34.

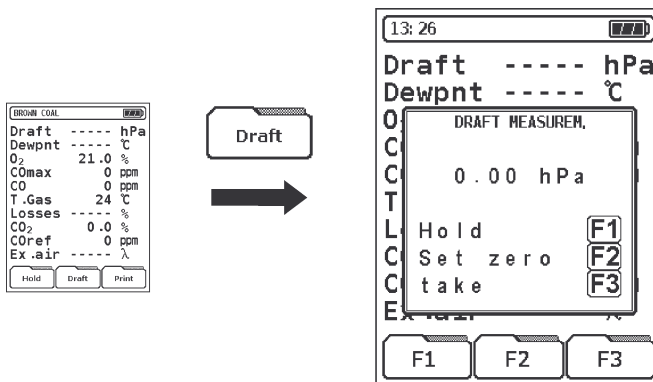
Measuring menu "Draft"

1. To determine the zero point in relation to the surrounding air pressure unplug the air tube (with the blue connector) before every draft measurement.
2. Press the F2 key.
3. Connect the air tube again.
4. Open the "Draft" measuring menu.







Key	Function
	Hold reading for draft (function "Hold").
	Carry out zero point calibration.
	Transfer draft value to the flue gas menu.
	Change representation of readings in the main menu line by line (multi-tasking-function).

Extra menu "Info"

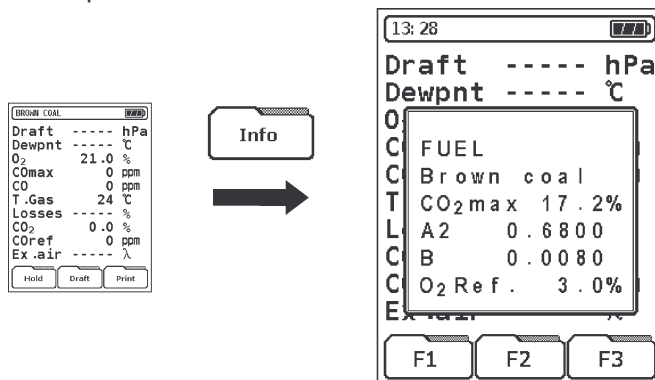
The most important fuel parameters and the O₂-reference value are shown.

- Open the "Info" extra menu.



Key	Function
	Change representation of readings in the main menu line by line (multi-tasking-function).
	Start the sensor quick-diagnosis, see below.
	Close "Info" extra menu.

- ▶ Open the sensor quick-diagnosis.

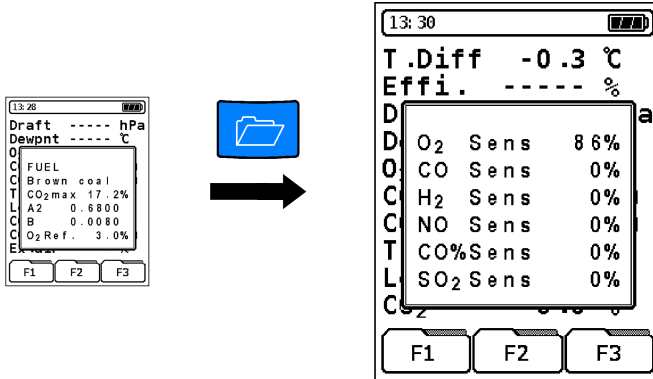

Sensor value	Diagnosis
O ₂ > 50 %	Oxygen cell OK
CO and H ₂ : 0 to 1 %	CO-sensor with H ₂ -compensation OK*)
CO%: 0 to 1 %	CO-sensor for upper range OK*)
NO and SO ₂ : 0 to 1%	NO- and/or SO ₂ -value OK*)

*) resp. sensor option disabled

Are other values found the corresponding sensor is either strongly impaired or used up.

- ▶ If so please contact the service point.



Extra menu "Draught detection"

The function "Draught detection" shows tendencies in a graphical way. Slightest changes in the temperature of the flue gas are shown with a black bar. If temperature is constant no bar appears.

The „Draught detection“ extra menu is only available for the measurement of the flue gas temperature in the "Flue gas" programme.

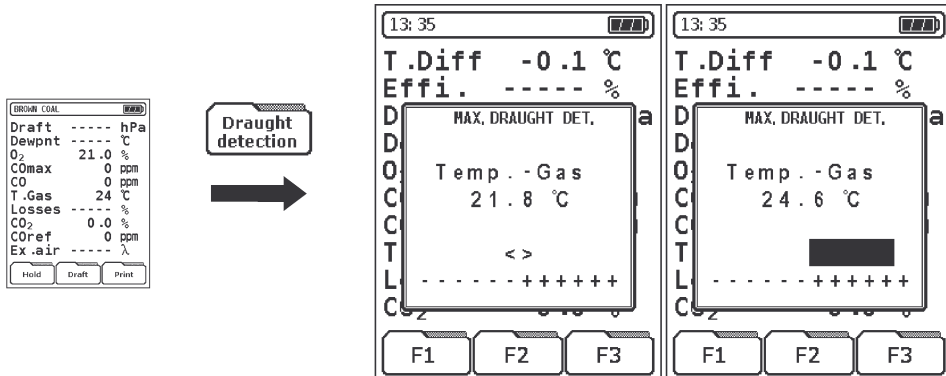
- Open the "Draught detection" extra menu.









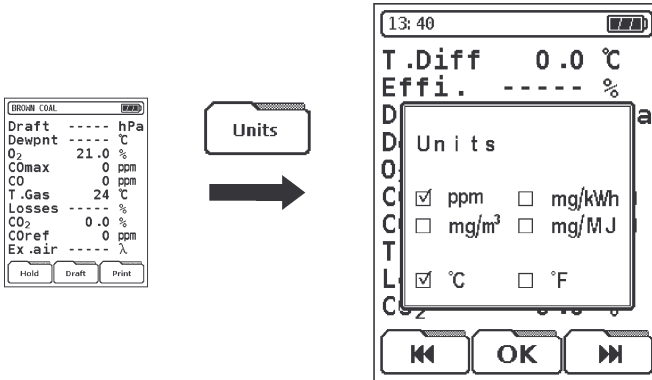

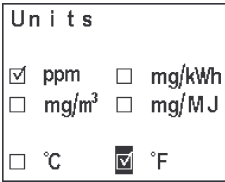

Key	Function
	Change representation of readings in the main menu line by line (multi-tasking-function).
	Close extra menu.

Extra menu "Units"

► Open the "Units" extra menu.



Register	Key	Function
 	 	Move the flashing cursor: 
		Confirm new "O ₂ reference value".
-		Change representation of readings in the main menu line by line (multi-tasking-function).
-		Cancel procedure and close menu. The "O ₂ reference value" used before will be kept.
-		Accept procedure and close menu. After the selected units have been confirmed they are available in the "Flue gas" menu from now on. This configuration is kept until new units are selected, no matter whether the device is switched off and on.

Extra menu "O₂-reference"

In order to convert the measured gas values the so called O₂ reference value can be modified in accordance with the current regulations and the chosen fuel respectively. For gas and oil fuels a value of 3 % is preset. For solid fuels a value of 13 % is preset.

- ▶ Open the "O₂-reference" extra menu.

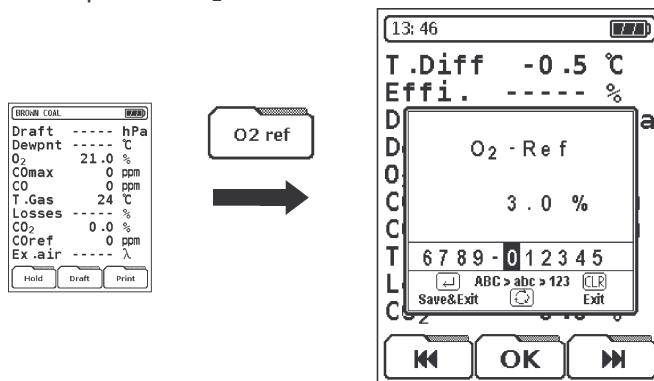





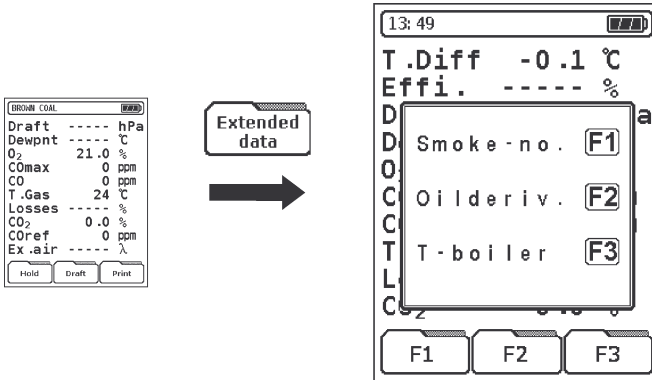

Register	Key	Function
		Select figure.
		Confirm.
-		Das Wechseln zwischen den Eingabezeichen (Großbuchstaben, Kleinbuchstaben und Zahlen) ist nicht zulässig. Nur Zahlenwerte verfügbar.
-		Cancel procedure and close menu. The "O ₂ reference value" used before will be kept.

Extra menu "Enter data"







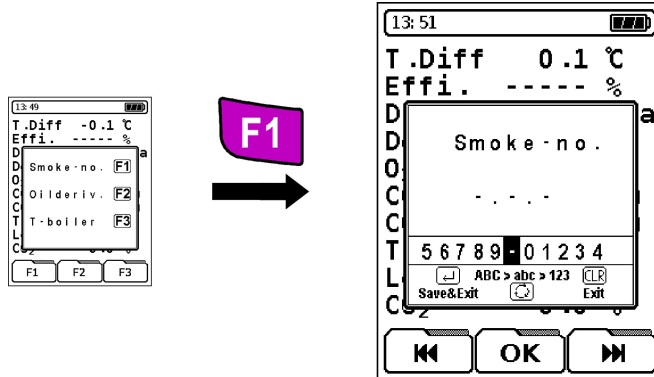

► Open the "Enter data" extra menu.



Key	Function
	Enter the found out Smoke-no. (soot content according to the Bacharach scale), see below.
	Enter the found out oil derivatives, see below.
	Enter temperature of boiler and heat carrier, see below.
	Change representation of readings in the main menu line by line (multi-tasking-function).
	Close menu.
	All data that has been confirmed with  so far will be stored in the measurement protocol. Inputs of data that have been cancelled will not be taken account of.





- Open the "Smoke-no." input menu.

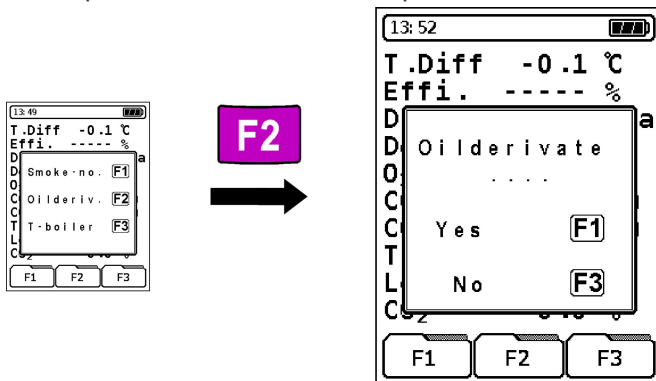

Register	Key	Function
		Select figure.
		
		Confirm selection.
-		Cancel procedure and close menu without keeping new data.
-		Confirm input and transfer data to the measurement protocol.







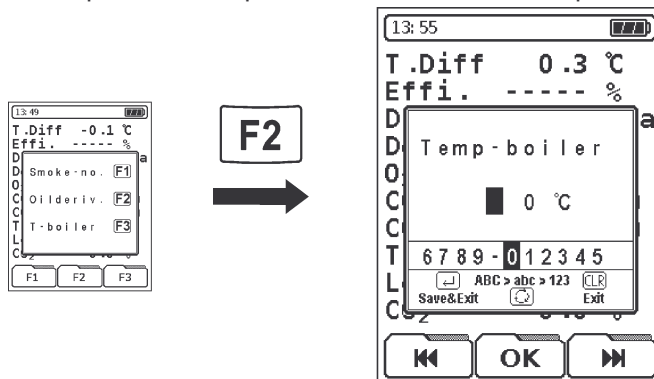

- ▶ Open the "Oil derivatives" input menu.



Key	Function
	Yes, oil derivatives existent.
	No, no oil derivatives existent.
	Cancel procedure and close menu without keeping new data.
	Confirm input and transfer data to the measurement protocol.

- Open the "Temperature and heat carrier" input menu.



Register	Key	Function
		Select figure. Bei Temperaturwerten kleiner 100 muss an der ersten Stelle eine „0“ (Null) eingegeben werden, z. B. 090 (= 90 °C).
		
		Confirm selection.
-		Cancel procedure and close menu without keeping new data.
-		Confirm input and transfer data to the measurement protocol.
-		Change representation of readings in the main menu line by line (multi-tasking-function).



Extra menu "Graphic"

This functions uses graphs to show the numerical values according to the chosen fuel. The remaining content of oxygen (O_2) and the calculated waste gas losses (qA) are thereby set in a relation to the excess air value (λ) and to the classical combustion diagram.

If both bars extend to the optimal fuel-air relation (the gap indicated by " λ_{opt} ") the firing facility in question is set in the correct way.

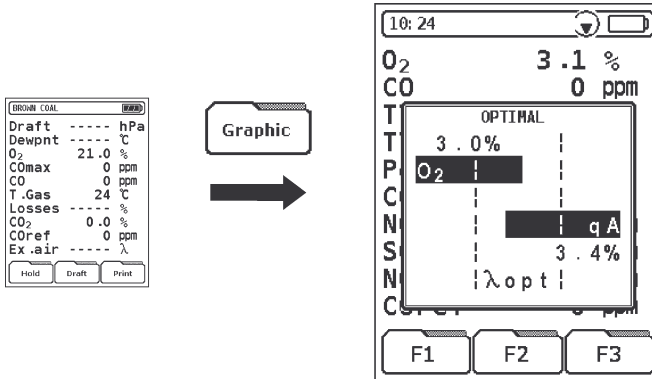
- Open the "Graphic" extra menu.





Key	Function
	Change representation of readings in the main menu line by line (multi-tasking-function).
	Close menu.

Menu "Fuel"

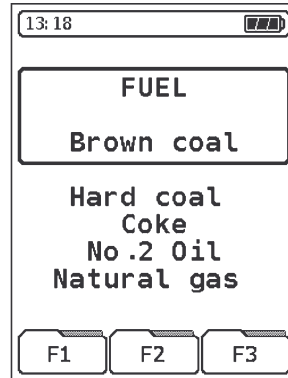
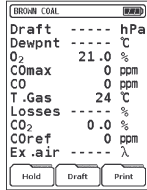
- ▶ Open the "Fuel" menu.



Key	Function
	Select new fuel.
	Confirm the selected fuel (fuel in the framed box).
	Cancel procedure without selecting new fuel.

Function "Programme macros"

Up to three customised measuring configurations can be created. They can be started directly out of the starting menu. The procedure of these macros can be reduced to a few key inputs only.

Programme macros can have configurations as shown below:

- Order of the readings that are shown on the screen
- Font size of the readings (5 or 10 characters)
- Predefined fuel
- Preset measuring units

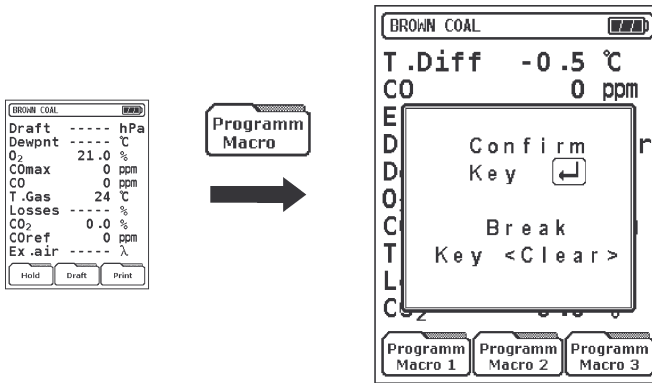

The list of available fuels is not shown after the calibration phase.

- ▶ Open the function "Programme macros".



Register	Key	Function
Programm Macro 1	F1	Save preset measurement configuration as programme macro.
Programm Macro 2	F2	
Programm Macro 3	F3	
-	CLEAR	Cancel procedure without saving data.
-	ENTER	Save macro.

Function "Hold"

Register	Key	Function
		Keep measured data. Press the key again to stop the HOLD-Function.

If the HOLD-Function is activated all displayed measured data at the time the key was pressed will be kept. If the HOLD-Function is activated the alert "HOLD" appears in the top left corner of the status line in exchange with the name of the fuel.

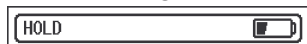

Function "Zoom"

There are two fonts and therefore types of layout available:

- **10 lines layout:** The 10 lines layout is the standard layout set by the producer. Measured parameters are shown on the left whereas readings and units are shown on the right.
- **5 lines layout:** This layout reduces the number of displayed lines but it facilitates the reading of the display from a bigger distance. Measured parameters and units are on the left whereas readings are on the right.

After the device is switched off and on again the display resets to the 10 lines layout automatically unless the 5 lines layout was a measurement configuration activated by a macro.

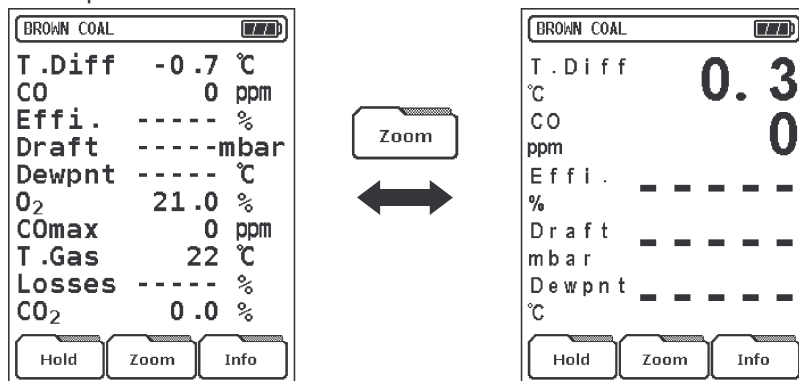

► Operate the function "Zoom".



Function "CO protect"

Every device is equipped with a second pump (CO-flushing-pump) in order to protect the quite sensitive CO-sensors from CO-overload.

The CO-flushing-pump can either be started manually or it switches on automatically when necessary, i.e. when the admitted CO-range is exceeded.

Register	Key	Function
		Switch CO-flushing-pump on/off. If the CO-flushing-pump starts automatically due to an excess concentration of CO it can't be switched off manually until the high CO-concentration is no danger for the CO-Sensor anymore. If the CO-concentration has reached the lower range again the CO-flushing-pump will shut off.

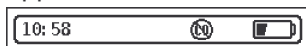

When the CO-flushing-pump is activated a scored out CO-symbol appears in the status line.



If the device is equipped with two CO-sensors the result of the higher range sensor will be displayed when the lower range sensor is flushed.

The active CO-flushing-pump doesn't influence any other sensors within the device.

Function "Print"

Register	Key	Function
		Print measured data.

The printer in use can be selected from the configuration menu, refer to chapter 11.3, page 50. The rate of printing depends mostly on the type of printer selected.

Because of the modern multi-tasking-operating the device can be used without restrictions during the printing procedure. Printing takes place simultaneously to the other procedures in order to avoid delays.

8.2 Programme "Temperature"

For temperature measurement there are two measurement channels (T1 and T2) available. Measurement channel T1 is displayed with a resolution of 0.1 °C whereas channel T2 has a resolution of 1 °C.

- ▶ Start the "Temperature" programme.

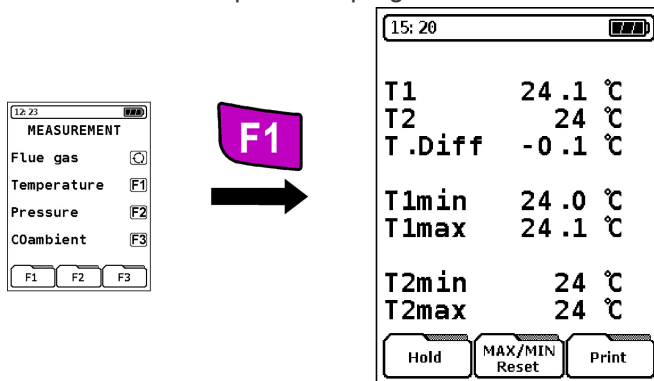

Register	Key	Function
Hold		Keep all temperature readings.
MAX/MIN Reset		Reset readings.
Print		Print measurement protocol.
-		Change units: °C, °F.
-		Close programme and back to the "Measure" menu.

8.3 Programme "Pressure"

- ▶ Start the "Pressure" programme.

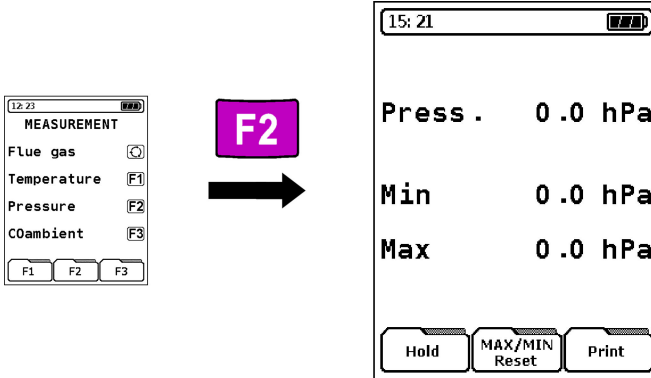

Register	Key	Function
		Keep all readings for pressure.
		Reset readings.
		Print measurement protocol.
-		Change units while the active measurement programme and in the HOLD-mode: hPa, mbar, mmWC (millimeter water column), mmHg, (Millimeter Mercury Column), inWC (Inch Water Column), inHg (Inch Mercury Column), Psi (Pounds Per Square Inch).
-		Reset to zero.
-		Close programm and back to the "Measure" menu.

The conversion takes place in the active measurement programme as well as in the HOLD-mode.

8.4 Programme "CO(O₂) Measurement"

- ▶ Start the "CO(O₂) Measurement" programm.

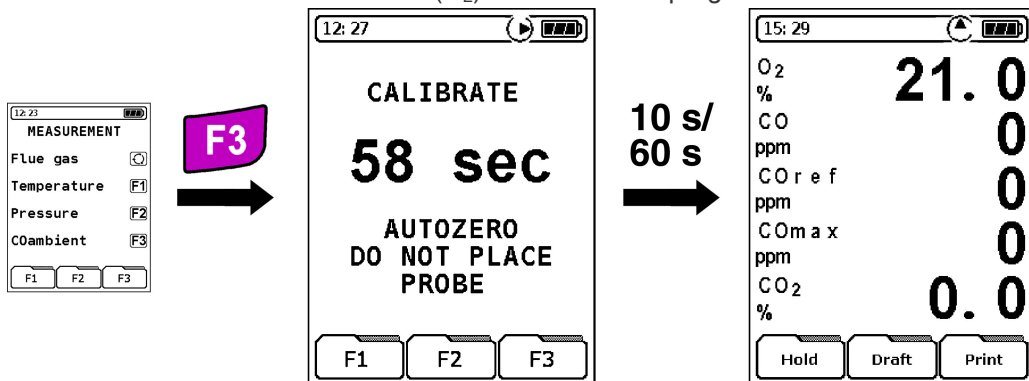

This is a reduced measurement (without temperature measurement) that can be carried out in the environment of the heating facility especially in the area of the flue gas channels.

For this programme the same keypad functions apply as described on page 21.

The number of readings is reduced to five significant flue gas values.

9 Menu "Macro Start"

The handling of the device can be facilitated enormously by means of customised measuring programme configurations that can be saved as programme-macros (refer to chapter Function "Programme macros", page 34). Up to three different and customised macros can be used.

Requirement for the use of macros are customised sets of measurement programme settings that can be started in an efficient way refer to chapter Function "Programme macros", page 34.

- Open the "Macro Start" menu.

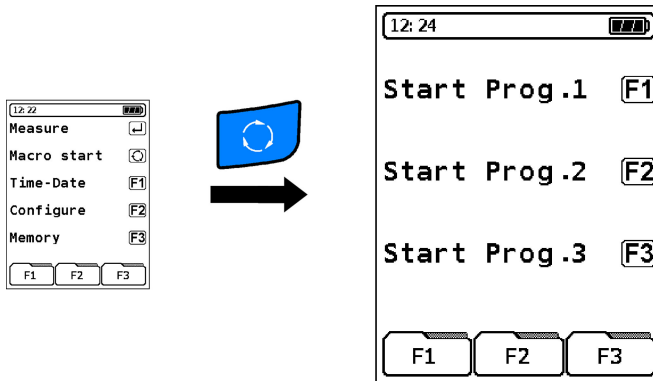

Key	Function
F1	Start required macro. After having started the macro the settings it is based on will be activated automatically after the calibration phase and without showing the list of fuels.
F2	
F3	

If a „Confi.-reset“, refer to chapter 11.4, page 54, is carried out all macro-settings will be lost. Without customised settings the settings for the fuel gas analysis will be used.

10 Menu "Time-Date"

The time will be displayed in the top left corner of the status line if not replaced by superior information. Time and date will be saved together with the corresponding data and therefore appear on the print-outs of measured data protocols as well.

In contrast to changes between winter and summer time and vice versa leap years will be considered automatically.

1. Open the "Time-Date" menu.

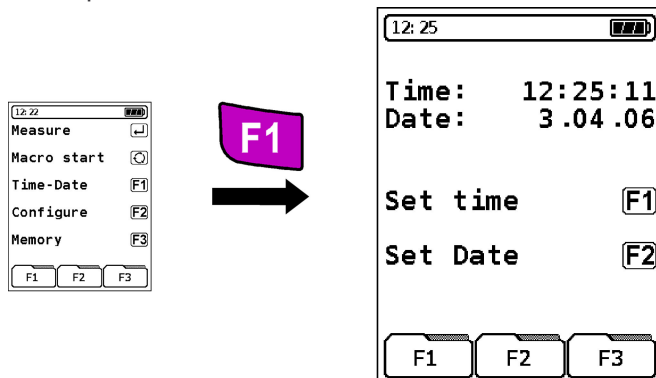

Key	Function
	Close menu.

2. Open the input menu for Time/Date.

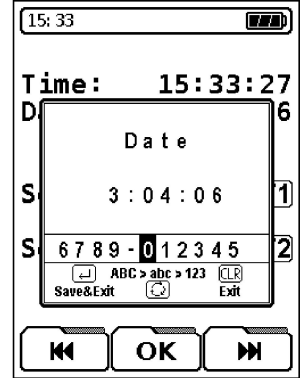
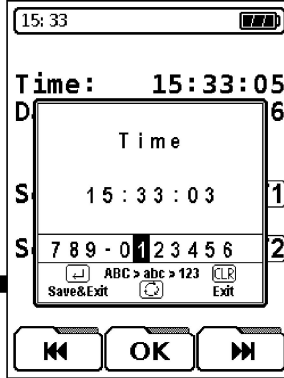
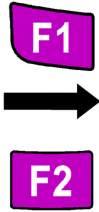
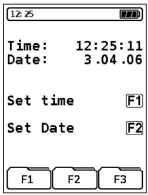

During time setting the clock in the editor will be stopped and not restarted until the new time is confirmed.



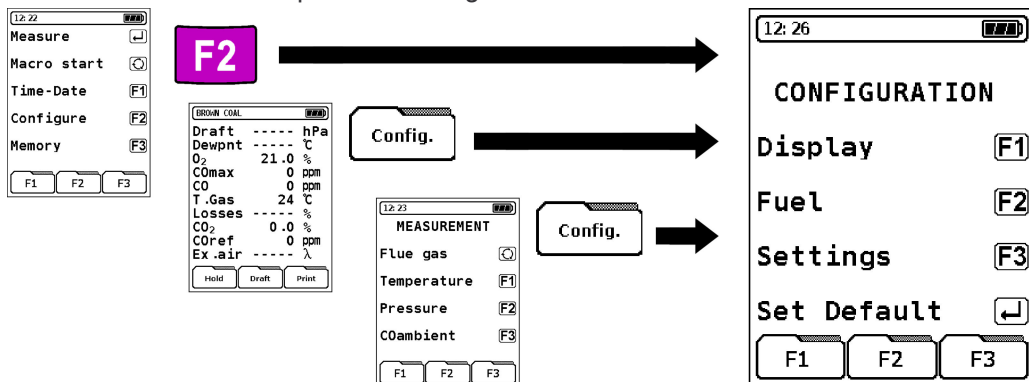

Register	Key	Function
		Change data.
		Confirm input.
-		Cancel procedure without saving data.
-		Save input.

11 Menu "Configuration"

► Open the "Configuration" menu.



In this menu customised measuring programme settings can be set. After being transferred into the active measurement programme these settings will be saved lastingly and are therefore producer-independent i.e. customised settings.





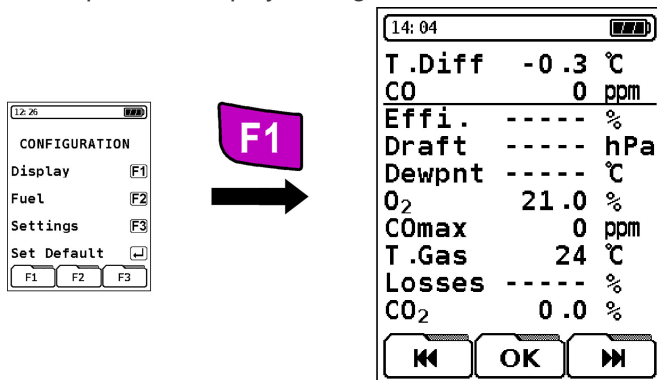

Key	Function
	Change order of measured values on the display, refer to chapter 11.1, page 44.
	Reduce/expand list of fuels, refer to chapter 11.2, page 46.
	Change general settings, refer to chapter 11.3, page 50.
	Restore factory settings, refer to chapter 11.4, page 54.
	Close configuration menu.

11.1 Change order of measured values on the display

The sequencing of the measured parameters can be altered in an arbitrary way. The same line can't be displayed more than once.



1. Open the "Display" configuration menu.

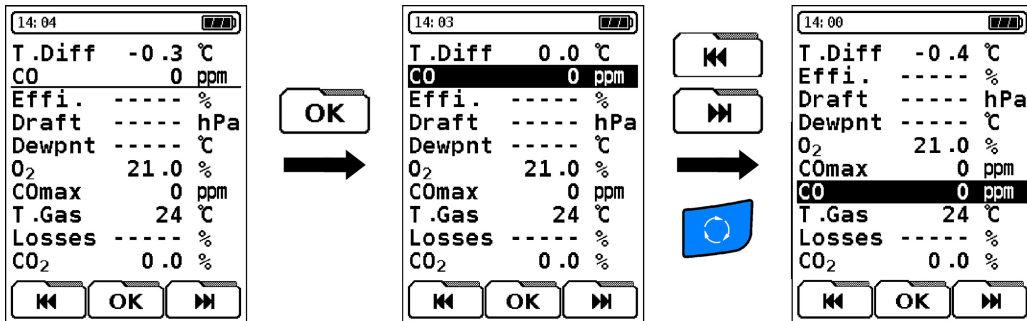

Register	Key	Function
		Move line cursor (underline) upwards or downwards.
		
-		Move line cursor (underline) in one direction.
-		Cancel procedure and back to the start menu.

2. Change order of measured values on the display.



Key	Function
	Cancel procedure without saving data.
	Confirm setting.

11.2 Configure list of fuels



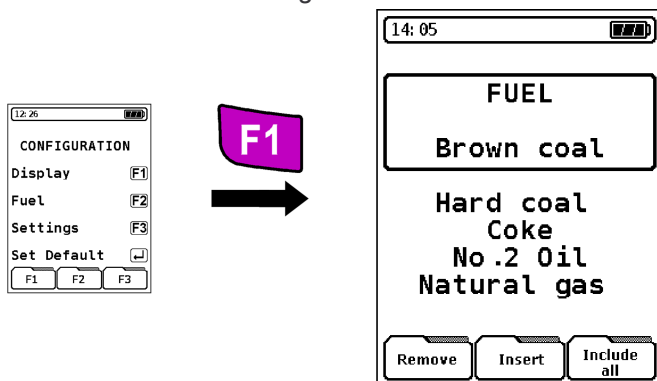



1. Start the "fuel" configuration menu.

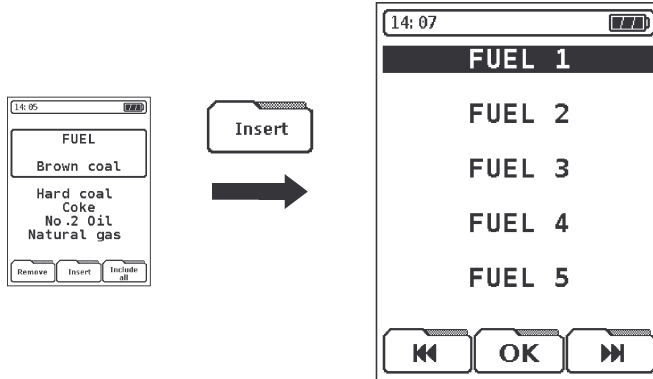

Register	Key	Function
Remove	F1	Remove framed fuel from list. The removed fuel can be reactivated later on by opening the complete list of available fuels again („Include all“).
Gesamt-liste	F3	Include all available fuels again.
Insert	F2	Insert new fuel. The available list of fuels will be expanded by a new fuel. There is a maximum of 5 more slots for fuels available that can be parameterised accordingly.

2. Inset new fuel.



Register	Key	Function
		Move bar cursor upwards or downwards.
		
		Confirm selected location of fuel.
-		Cancel procedure without saving data.

3. Edit new fuel.

14: 08		
FUEL		
FUEL 1		
CO ₂ max	0.0	%
A2	0.0000	
B	0.0000	
HW	0.00kWh/kg	
BW	0.00kWh/kg	
H ₂ O	0.0	%
Vat _r	0.0	m ³ /kg







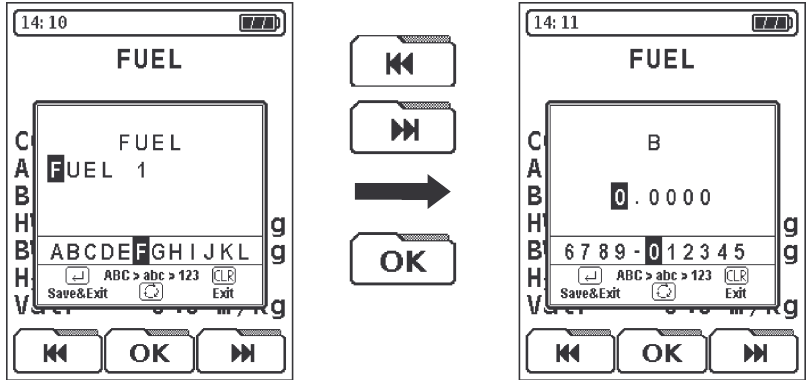

- HW** Heating value without condensation content
- BW** Heating value with condensation content
- H₂O** Content of water
- Vat_r** Quantity of flue gas (dry)

In order to create a new fuel the first three fuel-specific factors (CO₂max, A2 and B) have to be entered. If other units than ppm or % are used the other factors should be entered as well as otherwise a conversion to mg/m³, mg/kWh or MJ/m³ is not possible.

Register	Key	Function
		Select row: Name of fuel or attribute of fuel.
		Open selected row.
-		Cancel procedure.

4. Edit row.





Register	Key	Function
		Select required character.
		
		Confirm selected character.
-		Cancel procedure without saving data.
-		Save input and close.

11.3 Change settings

This menu is for general settings that represent programme independent functions.

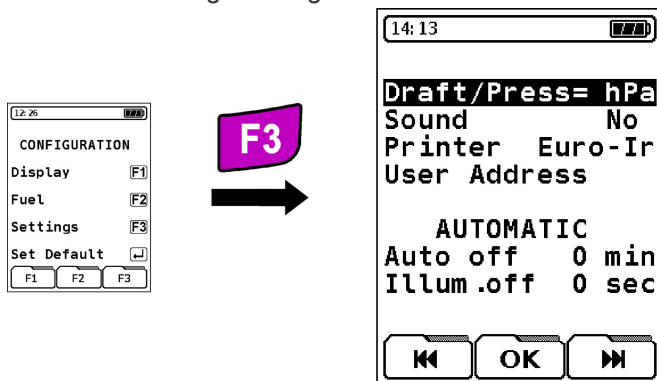



- ▶ Start "Settings" configuration menu.



Key	Function
	Select row. The bar cursor can only be moved in one direction.
	Cancel procedure.





Pressure/Draft

- ▶ Change the preselected unit for the pressure and draft measurement within the flue gas measurement programme.

Register	Key	Function
		Change unit: hPa, mbar, mmWC, mmHg, inWC, inHg, PSi.
		





Sound

- ▶ Switch on/off the sound when a key on the keypad is pressed.

Register	Key	Function
		Sound yes/no.
		

Printer

- ▶ Change the preselected infrared printer that is used for the proceedings of the readings (print-out).





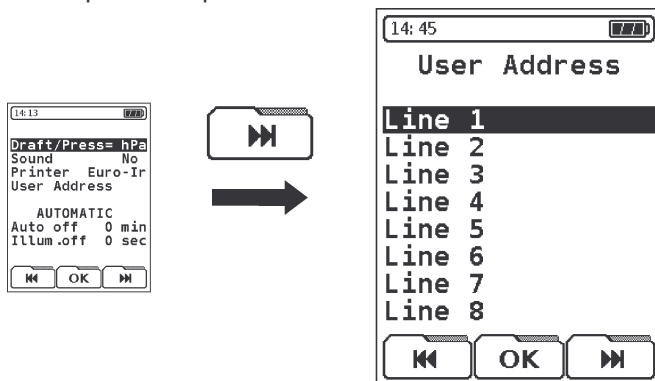

Register	Key	Function
		Change the printer: EUROprinter (Euro-Ir), HP84420B (HP-Ir).
		

User address

In this menu the address of the user can be entered. There are 8 lines available with 16 characters each (minuscules and capital letters, numbers and symbols).

1. Open the input menu for the address of the user.









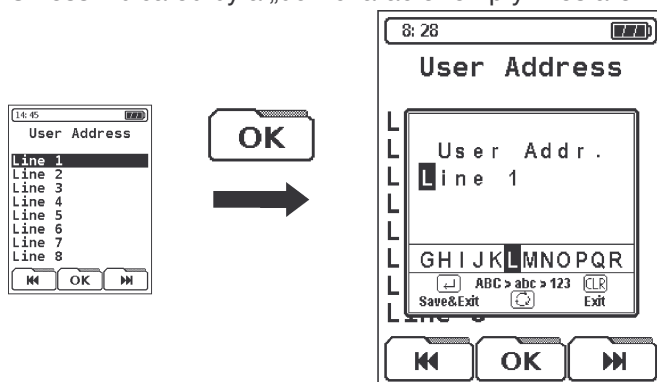

Register	Key	Function
		Select row.
		
		Activate selected row.
-		Cancel procedure and back to the "Settings" configuration menu.



2. Change selected row.

In the input mask (editor) only one line can be edited at a time. This entry mask is comparable to common mobile phone editors.

Unless indicated by a „dot“-character empty lines aren't printed.









Register	Key	Function
		Select type of character.
		
		Confirm character.
-		Change type of character: Minuscles and capital letters, numbers and symbols

Register	Key	Function
-		Cancel procedure without saving data.
-		Accept input and close editor.

Automatic

- **Auto off:** Time after which the device switches off automatically if no key is pressed. The auto off time can be set in intervals of 5 minutes. Maximum: 60 minutes.
If set to „0 min“ the auto off function is disabled and the device has to be switched off by hand via the ON/OFF key.
- **Illum. off:** Time interval for the backlight. This can be set in intervals of one second. Maximum: 30 seconds.

Register	Key	Function
		Decrease time interval.
		Increase time interval.
-		Cancel procedure without saving data.
-		Save input and close menu.



11.4 Set default settings

This function restores factory settings.

Attention: The restoration of the factory settings will cause a loss of all individual settings and can't be undone. The data memory is not affected.

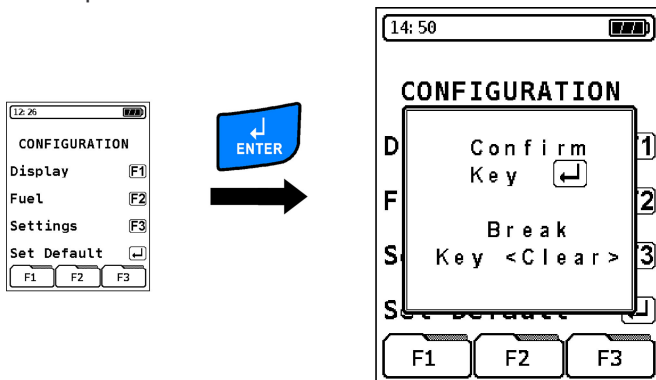
- ▶ Open the "Set default" function.



Key	Function
	Cancel procedure.
	Confirm the restoration of the factory settings.

12 Menu "Memory"

- ▶ Start the "Memory" menu.

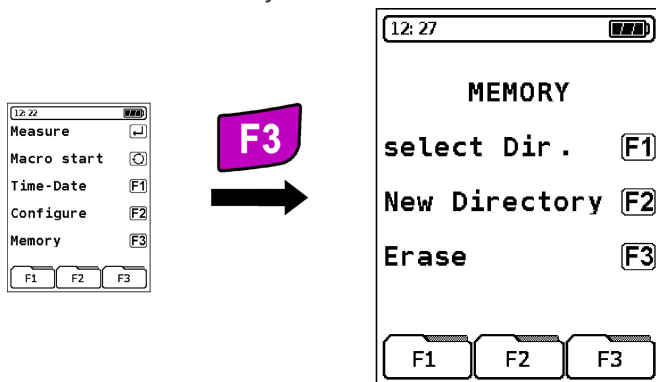

Key	Function
	Close memory and back to the start menu.

The data memory is structured as follows:

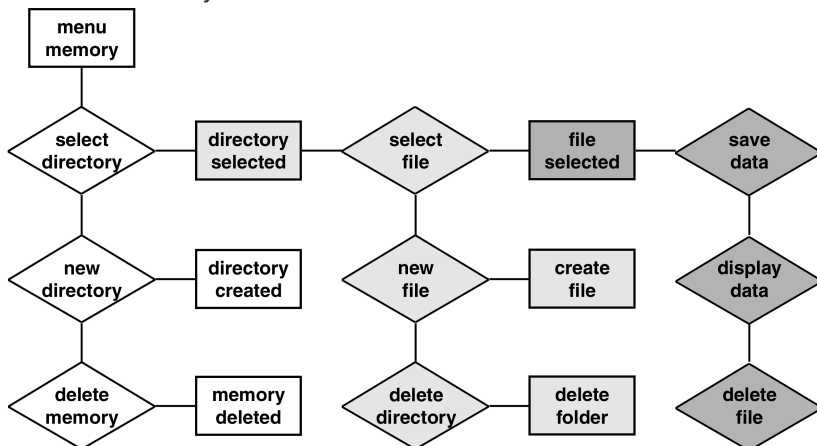

The organisation of the memory is dynamic, i.e. only already existing directories and files are available for saving data. Additional directories and files can be created at any time. Names of both directories and files can be defined by the user. Directories could for instance be used for the names of clients or facilities (or client numbers). Files could be named after the types of measurement.

New devices are delivered without preset directories and files:

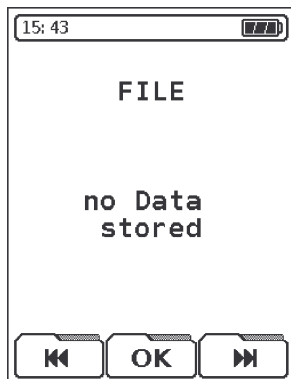

13 Operation

13.1 Notice concerning measurement of SO₂ and NO₂ (option)

SO₂ and NO₂ gases have a high solubility in water. For measurement of SO₂ and NO₂ concentrations it is therefore necessary to remove the condensate residues from the gas filtration and drying system. These residues can absorb SO₂ and NO₂ which could cause measurement deviations.

Furthermore, when carrying out SO₂ and NO₂ relevant measurements no additional desiccant should be used. Even when it is dry this filter material can absorb significant parts of the SO₂ and NO₂ content.

13.2 Battery/Line Voltage Operation

- Battery operation: Maximum of 10 hours of continuous measuring with backlight.
- Battery charger: External Charger 230 V~/50 Hz. Intelligent monitoring by means of an integrated charge-management-system.

13.3 Charging the batteries

CAUTION



Damage to the battery or the device because of using non-device-specific chargers.

- ▶ Use only the provided charger for charging the batteries.

1. Connect the device to the device-specific charger.
2. Switch the device on and off.

↳ The charging of the batteries starts automatically:

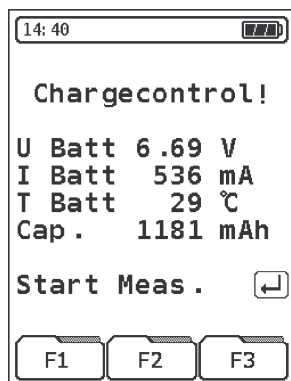

U Batt Current voltage
I Batt Current amperage
T Batt Measured battery temperature
Cap. Current battery capacity

Key	Function
	Start measurement while charging the battery.

↳ During measuring the battery will be recharged continuously and monitored by the system.

As soon as the battery is full the device switches to the passive recharging mode (trickle charging) automatically.

↳ The charge control screen disappears.

↳ When the (active) recharging is finished the charger can remain connected to the device without damaging the battery.

Service life and capacity of the battery

MULTILYZER NG is equipped with an NiMH storage battery. The service life and capacity of the battery are considerably affected by the way the instrument is charged and used. In order to make the handling safer, the instrument has an efficient and battery saving load management unit for all purposes.

The graphic charge-level indicator of the MULTILYZER NG consisting of 5 elements of a battery symbol helps the user to estimate correctly the capacity of the battery. **Es werden fünf verschiedene Akkuzustände detektiert.**

► During normal use it is recommended not to recharge the battery until it is run down completely.

The battery can be recharged at any time given the load management unit recognises the need of recharging the battery. If the battery is too full already the load management unit can deny a further recharging of it.

The service life of the NiMH battery can be significantly reduced when the instrument is operated at temperatures below 5 °C (40 °F).

Reconditioning cycle

If the device is used outside the permitted temperature range, if the battery is quite old or if incomplete charging cycles (charging/discharging) are carried out the charge-level indicator can possibly not show the true charge-level anymore. In this case the indicator can be corrected as explained in the following:

1. Discharge batteries by switching on the device until it runs out of battery power and switches off automatically.
2. Connect the device to the device-specific charger.
3. Switch the device on and off.
 - ↪ The charging of the batteries starts automatically. Recharging completely takes approx. 4 hours, depending on surrounding temperature.
 - ↪ After having finished active recharging the MULTILYZER NG switches off automatically.
4. Repeat the reconditioning cycle if necessary.

14 Maintenance

Waste Gas Cleaning System, refer to fig. 4, page 61.

- ▶ Empty the condensate reservoir completely after each measuring operation. Water residues within the measuring instrument will destroy the pumps and sensors.
- ▶ Check the micro filter for contaminations and replace as necessary.
- ▶ If the pump capacity is reduced, exchange the diaphragm filter. Damage of the filter and/or improperly fitted filter will greatly decrease or eliminate the filter function and will eventually destroy pumps and sensors.
- ▶ Make sure that threaded parts are straight when placed on and tighten them moderately. Ensure sufficient sealing by means of O-rings.
- ▶ Plug-type elements and flanges: Remove any gas residues. Grease with Vaseline.

Replacing the battery

For replacement of a used or dead battery, the analyser has to be sent back to the supplier/manufacturer.



- ▶ **Anschlussklemmen nicht kurzschließen.**
- ▶ Batteries may **not** be disposed together with unsorted household waste. Return empty batteries to a collection point or to your dealer for environmentally compatible disposal.

15 Troubleshooting

Repair work may only be performed by qualified, specially trained staff.

Table 7: Troubleshooting

Problem	Possible reason	Repair
Gerät schaltet automatisch ab	Akku leer	▶ Akku laden.
	Auto-Aus-Automatik aktiviert	▶ Auto-Aus-Automatik auf 0 stellen, siehe Kapitel „Automatic – Gerät aus“, Seite 53.
O ₂ -Fehlermeldung	Lebensdauer O ₂ -Sensor abgelaufe	▶ Gerät ohne Zubehör bei Frischluft laufen lassen
	Kurzzeitige Signalstörung	▶ Gerät zur Servicestelle bringen.

Problem	Possible reason	Repair
„CO-Wert zu hoch“-/“CO-Sensor defekt“-Meldung	CO-Sensor-Störung CO-Messbereich überschritten	▶ Gerät ohne Zubehör bei Frischluft laufen lassen.
	Sensorlebensdauer endet	▶ Gerät zum Service bringen.
Falsche Gasmesswerte (z. B.: O ₂ -Messwert zu hoch, CO ₂ -Wert zu niedrig, keine CO-Messwertanzeige, usw.)	Mess-System undicht	<ul style="list-style-type: none"> ▶ Gasaufbereitung auf Risse prüfen. ▶ Schlauchgarnitur auf Risse prüfen. ▶ O-Ringe Gasaufbereitung prüfen. ▶ O-Ring Sondenaußenrohr prüfen.
Servicemeldung	Gerät war längere Zeit nicht zur Überprüfung	▶ Gerät zum Service bringen.
Gasmesswerte werden langsam angezeigt	Filter in der Gasaufbereitung verbraucht	▶ Filter prüfen und gegebenenfalls austauschen.
	Schlauchgarnitur geknickt	▶ Schlauchgarnitur prüfen.
	Gaspumpe verschmutzt	▶ Gerät zur Servicestelle bringen.
Abgastemperatur instabil	Feuchtigkeit im Sondenrohr	▶ Sonde reinigen.
Gerät lässt sich nicht einschalten	Akku entladen	<ul style="list-style-type: none"> ▶ Akku aufladen, siehe Kapitel , Seite . ▶ Gerät zur Servicestelle bringen.
Other malfunctions.	–	▶ Send the device to the manufacturer.

16 Shutting down and disposal



- ▶ To protect the environment, this device must **not** be disposed of together with the normal household waste. Dispose of the device according to the local conditions and directives.

This device consists of materials that can be reused by recycling firms. The electronic inserts can be easily separated and the device consists of recyclable materials.

If you do not have the opportunity to dispose of the used device in accordance with environmental regulations, please contact us for possibilities to dispose of it or to return it.

17 Spare parts and accessories

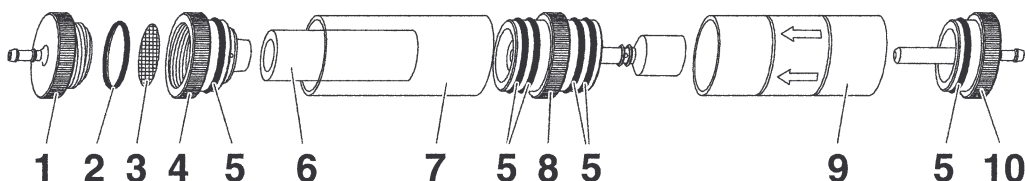

Fig. 4: Waste Gas Cleaning System – Watertrap

Part	Part No.
Watertrap	VK-00190
Spare parts for watertrap:	
Spare parts bag (5 x Infiltec filter and 5 x filterdisc)	VK-00208
(1) Outlet piece	20591
(2) O-ring 18 x 3	20365
(5) O-ring 23 x 2	20370
(3) Filterdisc 23,5 mm	20921
(4) Connection piece	20592
(6) Infiltec filter	20919
(7) Glass piston with logo	21778
(8) Middle part with cylinder	21990
(9) Glass piston with arrow mark	20596
(10) Inlet piece	20594

18 Warranty

The warranty of the manufacturer for this product is 24 months after the date of purchase. This warranty shall be good in all countries in which this device is sold by the manufacturer or its authorised dealers.

19 Copyright

The manufacturer retains the copyright to this manual. This manual may only be reprinted, translated, copied in part or in whole with the prior written consent of the manufacturer. We reserve the right to technical modifications with reference to the specifications and illustrations in this manual.

20 Customer satisfaction

Customer satisfaction is our prime objective. Please get in touch with us if you have any questions, suggestions or problems concerning your product.

21 Addresses

The addresses of our worldwide representations and offices can be found on the Internet at www.afriso.de.

22 Appendix

22.1 Declaration of conformity

<p style="text-align: center;">TCB</p> <p style="text-align: center;">GRANT OF EQUIPMENT AUTHORIZATION Certification Issued Under the Authority of the Federal Communications Commission</p> <p style="text-align: center;">By:</p> <p style="text-align: center;">EMCCert Dr. Rasek GmbH D-91329 Ebermannstadt, Germany</p> <p style="text-align: center;">Date of Grant: 04/10/2006 Application Dated: 04/10/2006</p>	<p style="text-align: center;">TCB</p> <p style="text-align: center;">GRANT OF EQUIPMENT AUTHORIZATION Certification Issued Under the Authority of the Federal Communications Commission</p> <p style="text-align: center;">By:</p> <p style="text-align: center;">EMCCert Dr. Rasek GmbH D-91329 Ebermannstadt, Germany</p> <p style="text-align: center;">Date of Grant: 04/10/2006 Application Dated: 04/10/2006</p>	<p style="text-align: center;">TCB</p> <p style="text-align: center;">GRANT OF EQUIPMENT AUTHORIZATION Certification Issued Under the Authority of the Federal Communications Commission</p> <p style="text-align: center;">By:</p> <p style="text-align: center;">EMCCert Dr. Rasek GmbH D-91329 Ebermannstadt, Germany</p> <p style="text-align: center;">Date of Grant: 04/10/2006 Application Dated: 04/10/2006</p>
<p>BlueGiga Technologies Inc. Sinkkilaentie 11 Espoo, FI-02630 Finland</p> <p>Attention: Mikael Björkas , Director of Production</p>	<p style="text-align: center;">NOT TRANSFERABLE</p> <p>EQUIPMENT AUTHORIZATION is hereby issued to the named GRANTEE, and is VALID ONLY for the equipment identified hereon for use under the Commission's Rules and Regulations listed below.</p> <p style="text-align: center;">FCC IDENTIFIER: OOOQVT12</p> <p>Name of Grantee: BlueGiga Technologies Inc. Equipment Class: Part 15 spread spectrum Transmitter Notes: Bluetooth Module</p>	<p style="text-align: center;">Emission Designator</p> <p style="text-align: center;">Frequency Tolerance</p> <p style="text-align: center;">Output WATTS</p> <p style="text-align: center;">FCC Rule Parts</p> <p style="text-align: center;">15C 2402.0 - 2480.0 0.00222</p>
<p>Modular Approval. Power output listed is conducted. This device and its antenna must not be co-located or operating in conjunction with any other antenna or transmitter.</p>		

<p style="text-align: center;">blue giga TECHNOLOGIES</p> <p style="text-align: center;">Declaration of Conformity</p> <p>Product type: WT12-A Bluetooth Module</p> <p>Manufacturer: BlueGiga Technologies Oy</p> <p>Application of Council Directive 73/23/EEC on the harmonization of laws related to Member States relating to electrical equipment designed for use within certain voltage limits, as amended by Council Directive 93/68/EEC and Council Directive 89/336/EEC on the approximation of the laws related to Member States relating to electromagnetic compatibility, as amended by: Council Directive 93/68/EEC.</p> <p>Referenced EMC Standards: ETSI EN 300 328-1 v1.3.1 (2001-12) ETSI EN 300 328-2 v1.2.1 (2001-12)</p> <p>Electromagnetic emission</p> <ul style="list-style-type: none"> - EN 301 489-17 v1.2.1: o EN 55022 (1998): Cont. conducted (Class B) o EN 55022 (1998): Radiated (Class B) <p>Electromagnetic immunity</p> <ul style="list-style-type: none"> - EN 301 489-17 v1.2.1: o EN 61000-4-2 (1995): ESD o EN 61000-4-3 (1995): EM Radiated field of RF 	<p>I, the undersigned, hereby declares that the equipment specified above conforms to the above Directives and Standards.</p> <p style="text-align: right;">  Mikael Björkas VP, Production </p> <p style="text-align: right;"> March 30th, 2006 </p> <p style="text-align: right; font-size: small;"> BLUEGIGA TECHNOLOGIES SINKKILAENTIE 11 P.O. BOX 118 FIN-02630 ESPOO TEL: +358 9 405 61 40 FAX: +358 9 405 61 40 Cst. ID: 994238-1, VAT registered, Domicile: Espoo WWW.BLUEGIGA.COM • B.F.O@BLUEGIGA.COM </p>
---	---